



FOR WHEN YOU NEED A LIFT, PULL OR TIE-DOWN



Northern Strands is the largest supplier of rigging, towing and tie-down products in *Western Canada*.

PRODUCT LISTING:

- Chain & Lever Hoists
- Wire Rope Slings
- Shackles
- Web & Round Slings
- Transport Chain & Accessories
- Tow Straps
- Double Braided Polyester Tow Rope
- 8 Strand Tow Rope
- 12 Strand Dyneema Rope
- 3 Strand General Purpose Polyester Rope
- Malleable clips and heavy duty Drop forged clips
- Thimbles
- Galvanized Aircraft Cable
- Turnbuckles
- Stainless Steel Aircraft Cable
- Bright Steel Cable

SASKATOON

3235 Millar Avenue, Saskatoon SK S7K 5Y3 FAX: (306) 249-4374
Ph: (306) 242-7073 Toll Free: 1-800-242-7073

REGINA

125 Henderson Drive, Regina SK S4N 5W4 FAX: (306) 352-9112
Ph: (306) 352-7073 Toll Free: 1-800-242-7073

Our competitive **ADVANTAGE...**

- Technically trained sales staff. We have the answers to your questions.
- Compliance certified equipment with documentation. Safe and approved for every job.
- Custom built products. i.e. material baskets, chain slings, wire rope slings and more.
- We work in the industry. We know your equipment needs from start to finish.

Welcome to Northern Strands

With health and safety in mind, Northern Strands has been supplying industry since 1970, evolving into five major divisions that offer needed tools and technical knowledge in mine hoisting and attachments, general rigging, engineered fall protection, suspended access and training.

Thanks to the experience and expertise of our people, Northern Strands is able to deliver added value from the start of your project whether feasibility, upgrade or modification. The design and planning stages are where the greatest potential for profitability for our customers is found.

Northern Strands Mining, Wire Rope, Attachments & Equipment Division excels by providing a wide range of equipment and services, by being the best full service provider of wire ropes, attachments, equipment and service. Truly Mine Hoisting Solutions®.

Our Rigging Division is a full-service facility operating out of Saskatoon and Regina with the ability to fabricate custom chain and wire rope slings. We have a vast inventory of synthetic lifting slings, chain hoists, lever hoists, shackles, trolleys, winches (tuggers), and other general rigging hardware. Our network of suppliers and in-house expertise is leveraged for the benefit of our customers. We have vertical and horizontal test bed services. Northern Strands provides compliance certified equipment with documentation.

The Engineered Fall Protection Division offers a variety of fall protection systems, solutions and services. Custom-engineered solutions can be designed to suit specific requirements. Services and equipment include: Inspection and replacement services for overhead and vertical lifelines. Consulting, supply and

installation services for single point anchors, guard rail systems, walkways and platforms and structural assessments.

Northern Strands has a large and diverse Suspended Access Division. Our suspended access solutions have been used on sloped roof buildings, glazing applications, sheeting, insulation and concrete restoration, surface and underground in the mining sector along with many other uses throughout Saskatchewan and Western Canada. All of our equipment goes through a rigorous inspection and recertification process each time before it leaves our shop to ensure that our equipment will provide the most dependable solution for your needs. We provide onsite technical assistance with all suspended access rigging and setup ranging from simple to highly engineered set-ups.

Northern Strands' Training Division offers several courses that aim to increase the workplace safety and make you compliant with the latest Saskatchewan OH&S legislation. Our instructors have been trained by industry leaders such as Crosby, Miller, and Capital Safety to name a few. Flexible scheduling [is] available, including evenings, nights and weekends. Courses are recognized province wide, and designed to educate you on legislation from The Occupational Health & Safety Regulations, 1996. Training courses offered: Fall Arrest, Crosby Rigging, Tugger Safety, Confined Space, Wirelock Socketing and First Aid/ CPR-C.

Northern Strands Certifications and Associations:

COR Safety certified, Canadian Red Cross partner, ISNET, Mission Zero Charter Member, Canadian Dam Association Sustaining Member

Call or visit us *today...*

SASKATOON

3235 Millar Avenue, Saskatoon SK S7K 5Y3
FAX: (306) 249-4374 **Ph: (306) 242-7073**

REGINA

125 Henderson Drive, Regina SK S4N 5W4
FAX: (306) 352-9112 **Ph: (306) 352-7073**

TOLL FREE: 1-800-242-7073

EMAIL: info@northernstrands.com

WEBSITE: www.northernstrands.com

email: sales@northernstrands.com



CHAIN AND LEVER HOISTS

Vitali International offers easy to use lever and chain hoists of the highest quality at affordable prices. These benefits combined with fast local service make Vitali hoists the perfect choice for all your material handling needs.

Did you know?

Chain and Lever hoists are used regularly by agriculture, automotive, construction, manufacturing and mining industries. Hoists have thousands of uses, from lifting vehicle engines to steel erection.

CHAIN HOISTS

- 1 Tonne Chain Hoists - 3m Fall
- 1 Tonne Chain Hoists - 6m Fall
- 1 Tonne Chain Hoists - 12m Fall

- 1.5 Tonne Chain Hoists - 3m Fall
- 1.5 Tonne Chain Hoists - 6m Fall
- 1.5 Tonne Chain Hoists - 12m Fall

- 2 Tonne Chain Hoists - 3m Fall
- 2 Tonne Chain Hoists - 6m Fall
- 2 Tonne Chain Hoists - 12m Fall

- 3 Tonne Chain Hoists - 3m fall
- 3 Tonne Chain Hoists - 6m fall
- 3 Tonne Chain Hoists - 12m fall

- 5 Tonne Chain Hoists - 3m Fall
- 5 Tonne Chain Hoists - 6m Fall
- 5 Tonne Chain Hoists - 12m Fall

- 10 Tonne Chain Hoists - 3m Fall
- 10 Tonne Chain Hoists - 6m Fall
- 10 Tonne Chain Hoists - 12m Fall

- 15 Tonne Chain Hoists - 3m Fall
- 15 Tonne Chain Hoists - 6m Fall
- 15 Tonne Chain Hoists - 12m Fall

- 20 Tonne Chain Hoists - 3m fall
- 20 Tonne Chain Hoists - 6m fall
- 20 Tonne Chain Hoists - 12m fall

LEVER HOISTS

- 0.25 Tonne Lever Hoist - 1.5m Fall
- 0.25 Tonne Lever Hoist - 4.5m Fall

- 0.5 Tonne Lever Hoist - 1.5m Fall
- 0.5 Tonne Lever Hoist - 4.5m Fall

- 0.8 Tonne Lever Hoist - 1.5m Fall
- 0.8 Tonne Lever Hoist - 4.5m Fall

- 1.6 Tonne Lever Hoist - 1.5m Fall
- 1.6 Tonne Lever Hoist - 4.5m Fall

- 3.2 Tonne Lever Hoist - 1.5m Fall
- 3.2 Tonne Lever Hoist - 4.5m Fall

- 6.3 Tonne Lever Hoist - 1.5m Fall
- 6.3 Tonne Lever Hoist - 4.5m Fall

- 9 Tonne Lever Hoist - 1.5m Fall
- 9 Tonne Lever Hoist - 4.5m Fall

SASKATOON

3235 Millar Avenue, Saskatoon SK S7K 5Y3 FAX: (306) 249-4374
Ph: (306) 242-7073 Toll Free: 1-800-242-7073

REGINA

125 Henderson Drive, Regina SK S4N 5W4 FAX: (306) 352-9112
Ph: (306) 352-7073 Toll Free: 1-800-242-7073



CHAIN HOISTS

We have the right Hoist for your job.

Standard Features

- Seal type caged ball bearings #21 & #21A on load sprocket
- Seal type caged ball bearings #21B & caged roller bearings #31B on the pinion shaft (minimize manual effort thanks to efficient drive train)
- Superior design of top hook holders for double / several columns of load chains
- Experience exceptional durability thanks to all-steel construction featuring rugged gear case enclosure and handwheel cover
- Enjoy increased lifting height thanks to low headroom
- Grade 100 heat-treated galv. alloy load chain resists abrasion and wear while minimizing chain weight
- Reinforced double pawl brake system and larger dia. pawl springs ensure reliable brake



Optional Features

- Overload protection system
- Patent fused brake disc
- Thrust bearings in bottom hook assembly
- Easy removable top hook



SASKATOON

3235 Millar Avenue, Saskatoon SK S7K 5Y3 FAX: (306) 249-4374
Ph: (306) 242-7073 Toll Free: 1-800-242-7073

REGINA

125 Henderson Drive, Regina SK S4N 5W4 FAX: (306) 352-9112
Ph: (306) 352-7073 Toll Free: 1-800-242-7073

Chain Hoists

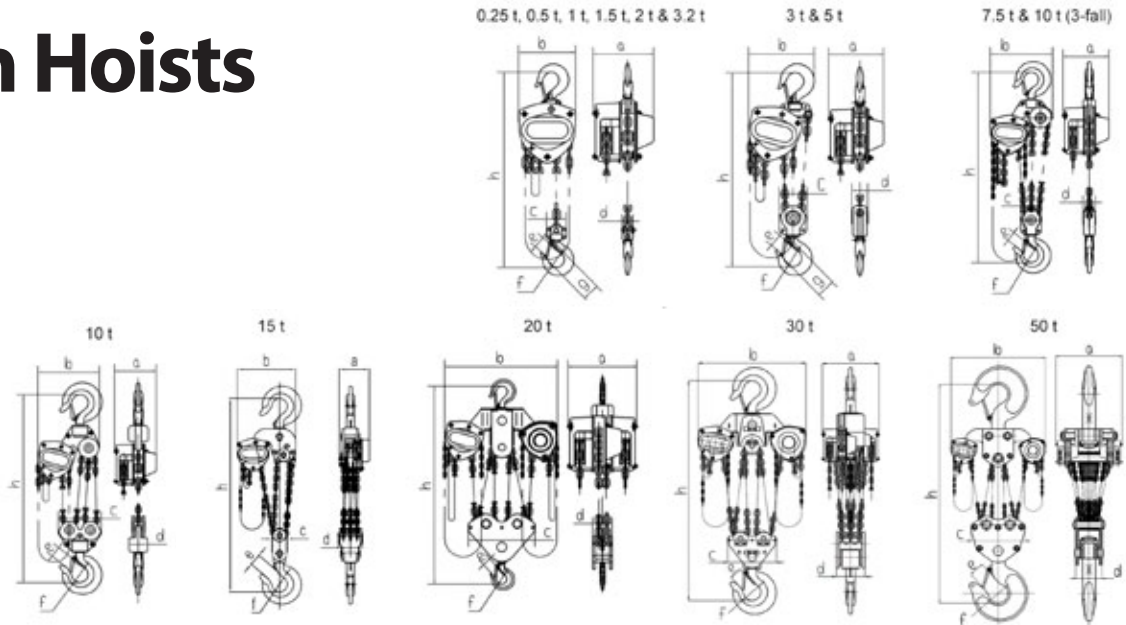

Capacity	(tonnes)	1	1.5	2	3	5	10	15	20	30	50
Model No.		K100	K150	K200	K300	K500	K1000	K1500	K2000	K3000	K5000
No. of Falls		1	1	1	2	2	4	6	8	12	20
Load Chain	(mm)	6.3 x 19	7.1 x 21	8 x 24	7.1 x 21	9 x 27	9 x 27	9 x 27	9 x 27	10 x 28	10 x 28
Load Chain Grade		100	100	100	100	100	100	100	100	100	100
Pull to Rated Load	(N)	284	343	353	353	333	353	363	353 x 2	345 x 2	345x 2
Proof Load	(tonnes)	1.5	2.25	3.0	4.5	7.5	15.0	22.5	25.0	37.5	62.5
Hand Chain	(mm)										
Standard Lift	(m)	3	3	3	3	3	5	5	5	5	8
Net Weight	(kg)	12.4	15.6	20	24	41	94.9	153	205	284	-
Gross Weight	(kg)	12.9	16.4	21	24.8	42.5	105	166	219	301	-
Extra Wt. per m	(kg)	1.8	2.1	2.3	3.2	4.4	7.9	11.4	15.8	29.3	46
Dimensions	a (mm)	161.5	170	183.5	170	192	192	220	230	360	585
	b (mm)	161	182	202.5	235	282	360.5	492	655	680	832
	c (mm)	51	64	64	106	133	263	110	286	306	482
	d (mm)	30	34	34	53	64	95	170	123	180	235
	e (mm)	33	33.5	37	43.5	51	64	80	82	82	133
	f (mm)	40	42	46	52	60	85	100	110	110	170
	g (mm)	45	47	52	62.5	79	-	-	-	-	-
	h (mm)	295	350	375	510	600	760	1,000	1,150	1,250	1,700

Custom chain lengths available. 30t to 50t available upon request.

SASKATOON

3235 Millar Avenue, Saskatoon SK S7K 5Y3 FAX: (306) 249-4374
Ph: (306) 242-7073 Toll Free: 1-800-242-7073

REGINA

125 Henderson Drive, Regina SK S4N 5W4 FAX: (306) 352-9112
Ph: (306) 352-7073 Toll Free: 1-800-242-7073



LEVER HOISTS

We have the right Hoist for your job.

Main Features

- More compact, very robust but light weight, short lever handle and low headroom.
- Grade 100 load chain.
- Interchangeable parts for standard and overload protected hoist.
- Reasonable pulling force to rated capacity.
- Unique hand wheel & knob design.
- No preload required.
- Innovative & patent fused brake disc.
- Heavy duty cast latches.
- Improved hook tip design.
- Caged roller bearings on load sprocket.
- Phosphoric surface treatment for the #3 driving shaft.
- Sizes range from .25, .5, .8, 1.6, 3.2 6.3, and 9 tonnes.

SASKATOON

3235 Millar Avenue, Saskatoon SK S7K 5Y3 FAX: (306) 249-4374
Ph: **(306) 242-7073** Toll Free: 1-800-242-7073

REGINA

125 Henderson Drive, Regina SK S4N 5W4 FAX: (306) 352-9112
Ph: **(306) 352-7073** Toll Free: 1-800-242-7073

Lever Hoists

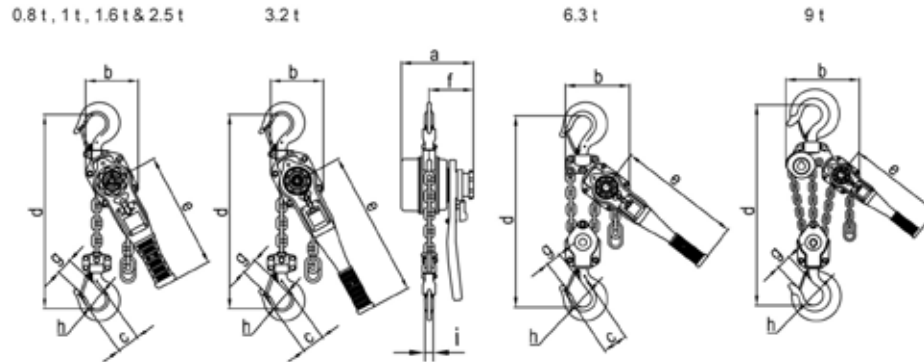

Capacity	(tonnes)	0.25	0.5	0.8	1.6	3.2	6.3	9
Model No.		KX025	KX050	KV008	KV016	KV032	KV063	KV090
No. of Falls		1	1	1	1	1	2	3
Load Chain	(mm)	3.2 x 9	4.3 x 12	5.6 x 15.7	7.1 x 19.9	10 x 28	10 x 28	10 x 28
Pull to Rated Load	(N)	223	324	215	304	372	382	392
Proof Load	(tonnes)	.375	.75	1.2	2.4	4.8	9.5	13.5
Standard Lift	(m)	1	1.5	1.5	1.5	1.5	1.5	1.5
Net Weight	(kg)	1.45	2.5	5.7	8.0	13.6	26.0	40.0
Gross Weight	(kg)	1.65	2.7	6.1	8.5	14.2	26.6	46.5
Extra Wt. per m	(kg)	0.22	0.37	0.7	1.1	2.3	4.7	7
Dimensions	a (mm)	87	100.5	146	164	196	196	196
	b (mm)	68	81	119	126	159	218	298
	c (mm)	200	250	41.5	52	61.9	84.3	-
	d (mm)	145	160	280	335	395	540	680
	e (mm)	55.5	62.5	245	265	415	415	415
	f (mm)	35.5	42	96	100	114	114	114
	g (mm)	21	24.5	26.5	35.5	43	53	64
	h (mm)	32	34.5	35.5	42.5	50	60	85
	i (mm)	11	12	14	19	24.5	34	40

SASKATOON

3235 Millar Avenue, Saskatoon SK S7K 5Y3 FAX: (306) 249-4374
Ph: (306) 242-7073 Toll Free: 1-800-242-7073

REGINA

125 Henderson Drive, Regina SK S4N 5W4 FAX: (306) 352-9112
Ph: (306) 352-7073 Toll Free: 1-800-242-7073

WIRE ROPE SLINGS

(STANDARD FLEMISH EYE EACH END)



Wire Rope Sling Features:

- Lowest cost per ton of lift of all slings
- Ideal for heavy loads and rugged conditions
- Flexible and abrasion resistant
- Wide range of possible end terminations

Cable Size	Cable Construction	W.L.L. (Vertical)	Length
1/4"	6X26	1,120 LBS	4, 6, 8, 10 FT.
3/8"	6X26	2,400 LBS	4, 6, 8, 10, 12, 14 FT.
1/2"	6X26	4,400 LBS	4, 6, 8, 10, 12, 14, 20 FT.
5/8"	6X26	6,800 LBS	4, 6, 8, 10, 12, 14, 16, 20 FT.
3/4"	6X26	9,800 LBS	6, 8, 10, 12, 16, 20 FT.
1"	6X36	17,000 LBS	6, 8, 10, 12, 16, 20 FT.
1-1/8"	6X36	20,000 LBS	8, 10, 12, 16, 20 FT.
1-1/4"	6X36	26,000 LBS	8, 10, 12, 16, 20 FT.
1-1/2"	6X36	36,000 LBS	8, 10, 12, 14, 16, 20 FT.

Larger Sizes & Lengths Available Upon Request.
Other Configurations Also Available.

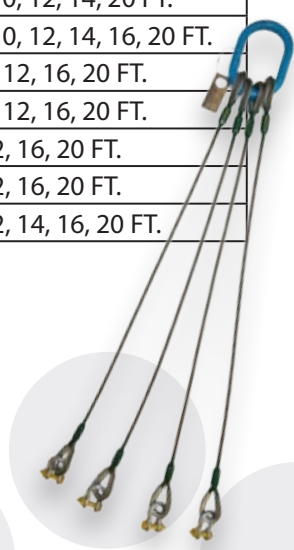

SASKATOON

3235 Millar Avenue, Saskatoon SK S7K 5Y3 FAX: (306) 249-4374
Ph: (306) 242-7073 Toll Free: 1-800-242-7073

REGINA

125 Henderson Drive, Regina SK S4N 5W4 FAX: (306) 352-9112
Ph: (306) 352-7073 Toll Free: 1-800-242-7073

SHACKLES



Screw Pin Anchor Bow Shackle

Federal Specification RR-C-271D, Type IVA, Grade A, Class 2

- (6:1 WLL) Galvanized, dimensions approx.
- Forged – Quenched and Tempered, Alloy Pins.
- Meets or exceeds all requirements of ASME B30.26."

NOMINAL SIZE (IN.)	WORKING LOAD LIMIT (tonne)
3/16	1/3
1/4	1/2
5/16	3/4
3/8	1
7/16	1-1/2
1/2	2
5/8	3-1/4
3/4	4-3/4
7/8	6-1/2
1	8-1/2
1-1/8	9-1/2
1-1/4	12
1-3/8	13-1/2
1-1/2	17
1-3/4	25
2	35
2-1/2	55

Safety Anchor Bow Shackle

Federal Specification RR-C-271D, Type IVA, Grade A, Class 3

- (6:1 WLL) Galvanized, dimensions approx.
- Forged – Quenched and Tempered, Alloy Pins.
- To assure traceability, "Yellow Pin" shackles are embossed to exceed ASME B30.26 requirements

NOMINAL SIZE (IN.)	WORKING LOAD LIMIT (tonne)
1/4	1/2
5/16	3/4
3/8	1
7/16	1-1/2
1/2	2
5/8	3-1/4
3/4	4-3/4
7/8	6-1/2
1	8-1/2
1-1/8	9-1/2
1-1/4	12
1-3/8	13-1/2
1-1/2	17
1-3/4	25
2	35



Long Reach Screw Pin Shackle

- Design factor of 5:1
- Meets the requirements of ASME B30.26
- Alloy Steel
- WLL forged on body
- Durable orange powder coated finish

NOMINAL SIZE (IN.)	WORKING LOAD LIMIT (lbs.)
5/8	7,000
3/4	10,000
1	19,000
1-1/4	28,000
1-1/2	34,000
1-3/4	50,000

SASKATOON

3235 Millar Avenue, Saskatoon SK S7K 5Y3 FAX: (306) 249-4374
Ph: (306) 242-7073 Toll Free: 1-800-242-7073

REGINA

125 Henderson Drive, Regina SK S4N 5W4 FAX: (306) 352-9112
Ph: (306) 352-7073 Toll Free: 1-800-242-7073

WEB & ROUND SLINGS

Product listing

**UNITEX BRAND SUPPLIED
BY NORTHERN STRANDS.**

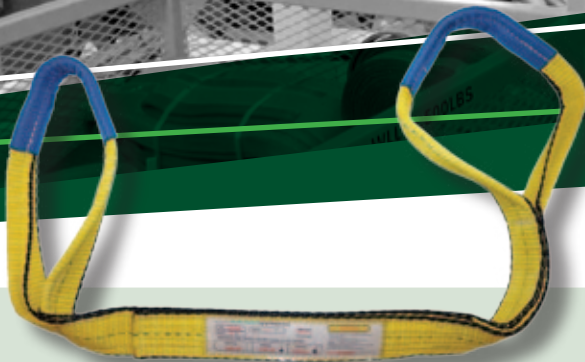

POLYESTER WEB SLINGS

1" 2 ply from 3' up to 12' WLL 3200lbs Vertical

2" 2 ply from 2' up to 20' WLL 6400lbs Vertical

3" 2 ply from 4' up to 20' WLL 8600lbs Vertical

4" 2 ply from 4' up to 20' WLL 11500lbs Vertical

*All other sizes and configurations available upon request.
All eyes have blue protective covering. All eyes are tapered.*



POLYESTER ROUND SLINGS (DOUBLE SLEEVED)

3,000lbs Vertical WLL, Purple sleeve, Lengths 3' up to 20'

6,000lbs Vertical WLL, Green sleeve, Lengths 3' up to 20'

9,000lbs Vertical WLL, Yellow sleeve, Lengths 3' up to 20'

12,000lbs Vertical WLL, Tan sleeve, Lengths 6' up to 20'

14,000lbs Vertical WLL, Red sleeve, Lengths 6' up to 20'

*All other sizes and lengths available upon request.
All round slings have hidden I.D. tag.*

SASKATOON

3235 Millar Avenue, Saskatoon SK S7K 5Y3 FAX: (306) 249-4374
Ph: (306) 242-7073 Toll Free: 1-800-242-7073

REGINA

125 Henderson Drive, Regina SK S4N 5W4 FAX: (306) 352-9112
Ph: (306) 352-7073 Toll Free: 1-800-242-7073



TRANSPORT CHAIN AND ACCESSORIES



Transport Chain, Grade 70
1/4", 5/16", 3/8", 1/2"

- High tensile carbon steel. Heat treated.
- Minimum Ultimate load is 4 times the Working Load Limit. Design factor of 4 to 1.
- Gold dichromate finish.
- Meets ASTM & NACM standards.
- Available in custom lengths.

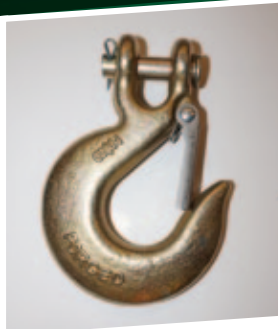

Grade 70 grab and slip hooks

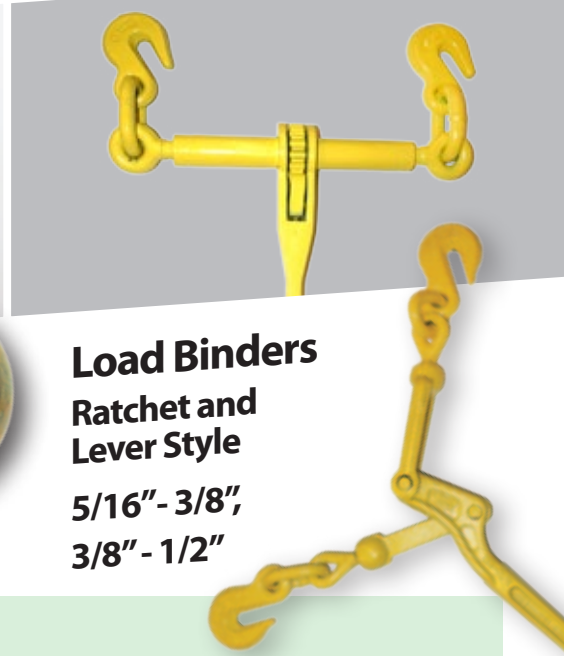

Load Binders Ratchet and Lever Style
5/16" - 3/8",
3/8" - 1/2"

Did you know?

Grade 70 transport chain assemblies have distinct advantages over Grade 43 assemblies. Grade 70 assemblies have a higher load rating and are smaller in size. This makes Grade 70 assemblies easier to work with, lighter and makes for convenient storage. Who benefits from these advantages? Anyone who needs to tow, haul, lash, or tie down a load."

SASKATOON

3235 Millar Avenue, Saskatoon SK S7K 5Y3 FAX: (306) 249-4374
Ph: (306) 242-7073 Toll Free: 1-800-242-7073

REGINA

125 Henderson Drive, Regina SK S4N 5W4 FAX: (306) 352-9112
Ph: (306) 352-7073 Toll Free: 1-800-242-7073

TOW STRAPS

Benefits of Northern Strands Tow Straps:

- Do not absorb water
- Polyester slings that reduce stretching
- Padded eye to reduce wear
- Tagged and certified for breaking strength

Common Tow Straps in stock. Other sizes available upon request.

GREEN

- 2 Ply, 32,000lbs **Green 2" x 20'**
- 2 Ply, 32,000lbs **Green 2" x 30'**
- 2 Ply, 32,000lbs **Green 2" x 50'**

GREY

- 2 Ply, 64,000lbs **Grey 4" x 30'**
- 2 Ply, 64,000lbs **Grey 4" x 50'**

BLUE

- 2 Ply, 128,000lbs **Blue 8" x 30'**
- 2 Ply, 128,000lbs **Blue 8" x 50'**

YELLOW

- 2 Ply, 48,000lbs **Yellow 3" x 20'**
- 2 Ply, 48,000lbs **Yellow 3" x 30'**

BROWN

- 2 Ply, 96,000lbs **Brown 6" x 20'**
- 2 Ply, 96,000lbs **Brown 6" x 30'**
- 2 Ply, 96,000lbs **Brown 6" x 50'**

ORANGE

- 2 Ply, 160,000lbs **Orange 10" x 30'**
- 2 Ply, 160,000lbs **Orange 10" x 50'**
- 2 Ply, 192,000lbs **Orange 12" x 30'**
- 2 Ply, 192,000lbs **Orange 12" x 50'**

SASKATOON

3235 Millar Avenue, Saskatoon SK S7K 5Y3 FAX: (306) 249-4374
Ph: **(306) 242-7073** Toll Free: 1-800-242-7073

REGINA

125 Henderson Drive, Regina SK S4N 5W4 FAX: (306) 352-9112
Ph: **(306) 352-7073** Toll Free: 1-800-242-7073

email: sales@northernstrands.com

EVER BEEN STUCK?

DOUBLE BRAIDED POLYESTER TOW ROPE (WITH OR WITHOUT PADDED EYES)



Our premium double braided polyester rope designed for general marine, industrial, and commercial use where low elongation, high strength, and abrasion resistance are required. Constructed from the highest quality UV stabilized yarns.

Larger sizes available. Custom lengths available upon request.

Features:

- Specific Gravity of 1.38
- Low Elongation
- High Strength
- Excellent Dielectrics
- Abrasion Resistance
- UV Stabilized Cover

Available Suggested Uses:

- Vehicle Recovery
- Winch Lines
- Pulling Lines
- Retrieval Lines
- Towing

Eye Splice Method:

- Double Braid Class 1

Size		Circ. Inch	Approx. Weight		Approx. Avg. Tensile Strength	
Dia. In	Dia. MM		Lbs/100ft	Kg/100M	Lbs	Kg
3/4"	18	2-1/4"	18.2	27.1	21,800	9,888
1"	24	3"	33.3	49.6	39,200	17,781
1-1/4"	30	3-3/4"	52.5	78.1	56,500	25,628
1-1/2"	36	4-1/2"	71.5	106.4	78,000	35,380

SASKATOON

3235 Millar Avenue, Saskatoon SK S7K 5Y3 FAX: (306) 249-4374
Ph: (306) 242-7073 Toll Free: 1-800-242-7073

REGINA

125 Henderson Drive, Regina SK S4N 5W4 FAX: (306) 352-9112
Ph: (306) 352-7073 Toll Free: 1-800-242-7073



FOR THOSE BIG TOW JOBS

8 STRAND TOW ROPE

Our premium 8 Strand Tow rope is manufactured from high tenacity polypropylene yarns, Superdan offers easy handling, high strength and excellent abrasion resistance.

Features:

- Excellent anti-abrasion properties contribute to longer working life
- High UV light resistance
- Highly flexible, easy to handle
- 50% better breaking strength compared to BS and ISO standards

Applications:

- Mooring lines
- General and commercial fishing rope
- Anchor lines
- Equipment towing
- Tractor towing

Technical Specs:

- Class II Rope
- Specific Gravity: 0.91
- Elastic Elongation Percentage: At % of breaking strength – 20-22%
- Splicing Procedures Required
- Eye splice – 8-strand/Class II Rope
- End for End splice – 8-strand/Class II Rope

Dia.	Circ.	Dia. mm	Weight per 100 ft.	Min. Break Strength/LBS
1-5/8"	5	40	53.1	62,500
2"	6	48	80.2	91,400
2-1/4"	7	56	108.5	120,600
2-5/8"	8	64	141.1	155,000
3"	9	72	178.1	197,100

SASKATOON

3235 Millar Avenue, Saskatoon SK S7K 5Y3 FAX: (306) 249-4374
Ph: (306) 242-7073 Toll Free: 1-800-242-7073

REGINA

125 Henderson Drive, Regina SK S4N 5W4 FAX: (306) 352-9112
Ph: (306) 352-7073 Toll Free: 1-800-242-7073

All rope end fittings spliced into rope at Northern Strands Saskatoon Manufacturing plant.

NO SPLINTERS, NO KINKS, NO CURLS, NO HASSLE...

Dyneema Winch Lines.

Available at Northern Strands



12-strand Dyneema Rope Uses:

Winch Line, Anchor Line, Dock/Mooring Line, Tow Rope, Lanyards, Hand Lines, Hoisting Ropes, Slings, Climbing Rope, Utility Rope.

All rope comes with hook, latch, thimble

3/16 x 50'	1/4 x 50'	5/16 x 50'	3/8 x 50'
3/16 x 75'	1/4 x 75'	5/16 x 75'	3/8 x 75'
3/16 x 100'	1/4 x 100'	5/16 x 100'	3/8 x 100'

Other sizes and lengths available.

The Benefits of Dyneema Rope:

- Upgrade your Winch with stronger Synthetic Winch Rope than Traditional Steel Cables.
- The Synthetic Dyneema Rope won't Kink, Curl or Splinter.
- Extremely Light, Floats in Water.
- Minimal Stretch and Non Rotation.
- Easy to Handle Splice, No Sharp Frays.
- Good Resistance to UV and Chemicals.
- Workable below -20 degree centigrade.

SASKATOON

3235 Millar Avenue, Saskatoon SK S7K 5Y3 FAX: (306) 249-4374
Ph: (306) 242-7073 Toll Free: 1-800-242-7073

REGINA

125 Henderson Drive, Regina SK S4N 5W4 FAX: (306) 352-9112
Ph: (306) 352-7073 Toll Free: 1-800-242-7073



3 STRAND GENERAL PURPOSE POLY ROPE



Features:

- Color yellow
- 100% high tenacity monofilament fiber
- Holds knots well
- Floats

Applications:

- Recreation
- Hunting
- General construction
- Tarping
- Camping
- Boating

Technical Specifications:

- General purpose poly
- Specific gravity: 98 (floats)
- Easy to splice
- Eye splice
- End for end splice

SIZE	LENGTH
3/16"	2125 FT.
1/4"	1300 FT.
5/16"	975 FT.
3/8"	630 FT.
1/2"	335 FT.
5/8"	200 FT.
3/4"	125 FT.

SASKATOON

3235 Millar Avenue, Saskatoon SK S7K 5Y3 FAX: (306) 249-4374
Ph: (306) 242-7073 Toll Free: 1-800-242-7073

REGINA

125 Henderson Drive, Regina SK S4N 5W4 FAX: (306) 352-9112
Ph: (306) 352-7073 Toll Free: 1-800-242-7073

MALLEABLE CLIPS AND HEAVY DUTY DROP FORGED CLIPS



- To be used for light Duty, NON CRITICAL applications only.
- Typical uses includes guard line and fencing,
- Federal Specifications FF-C-450, Type 1 Class 2.

The Right Way



The Wrong Way

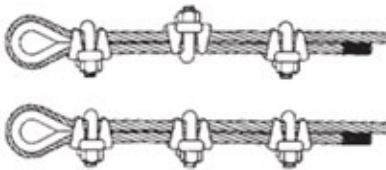

MALLEABLE CLIPS (LIGHT DUTY)	
ROPE SIZE	WEIGHT (100 PCS.)
1/8"	4 LBS
3/16"	6.3 LBS
1/4"	13 LBS
5/16"	15 LBS
3/8"	21 LBS
1/2"	37 LBS
5/8"	59 LBS
3/4"	84 LBS
7/8"	125 LBS
1"	166 LBS

DROP FORGED CLIPS (HEAVY DUTY)	
ROPE SIZE	WEIGHT (100 PCS.)
1/8"	6 LBS
3/16"	10 LBS
1/4"	20 LBS
5/16"	30 LBS
3/8"	47 LBS
1/2"	80 LBS
9/16"	104 LBS
5/8"	106 LBS
3/4"	150 LBS
7/8"	212 LBS
1"	260 LBS
1-1/8"	290 LBS
1-1/4"	430 LBS
1-1/2"	540 LBS
1-3/4"	925 LBS
2"	1,300 LBS
2-1/4"	1,540 LBS
2-1/2"	1,980 LBS
2-3/4"	2,200 LBS
3"	3,080 LBS
3-1/2"	3,960 LBS

Forged Wire Rope Clip

- Meets Federal Specification FF-C-450, Type 1 Class 1.
- Each base has product identification code for material traceability, the name 'OCEAN' & size to meet ASME B30.26
- Entire clip galvanized with powder coated Yellow U-Bolt.
- Only genuine 'OCEAN' clips have yellow U-Bolt for instant recognition.

SASKATOON

3235 Millar Avenue, Saskatoon SK S7K 5Y3 FAX: (306) 249-4374
Ph: (306) 242-7073 Toll Free: 1-800-242-7073

REGINA

125 Henderson Drive, Regina SK S4N 5W4 FAX: (306) 352-9112
Ph: (306) 352-7073 Toll Free: 1-800-242-7073



THIMBLES



Light Duty Thimbles

ROPE SIZE	WEIGHT (100 PCS.)
1/8"	3.5 LBS
3/16"	3.5 LBS
1/4"	3.5 LBS
5/16"	4.0 LBS
3/8"	6.7 LBS
1/2"	12.5 LBS
5/8"	34.5 LBS
3/4"	47.1 LBS
7/8"	84.6 LBS
1"	97.5 LBS



Heavy Duty Thimbles

ROPE SIZE	WEIGHT (100 PCS.)
1/4"	6.5 LBS
5/16"	11.8 LBS
3/8"	21.6 LBS
7/16"	34.7 LBS
1/2"	51 LBS
9/16"	51 LBS
5/8"	75.7 LBS
3/4"	158 LBS
7/8"	177 LBS
1"	313.9 LBS
1-1/8"-1-1/4"	400 LBS
1 1/4"-1-3/8"	811 LBS
1-1/2"	1,295 LBS
1-3/4"	1,775 LBS
2"	2,775 LBS



Stainless Steel Thimbles

LIGHT DUTY	
ROPE SIZE	WEIGHT (100 PCS.)
1/16"	0.5 LBS
1/8"	0.75 LBS
3/16"	1.0 LBS

HEAVY DUTY	
ROPE SIZE	WEIGHT (100 PCS.)
1/4"	6.5 LBS
5/16"	11.8 LBS
3/8"	21.6 LBS
1/2"	51 LBS
5/8"	75.7 LBS
3/4"	158.10 LBS

SASKATOON

3235 Millar Avenue, Saskatoon SK S7K 5Y3 FAX: (306) 249-4374
Ph: (306) 242-7073 Toll Free: 1-800-242-7073

REGINA

125 Henderson Drive, Regina SK S4N 5W4 FAX: (306) 352-9112
Ph: (306) 352-7073 Toll Free: 1-800-242-7073

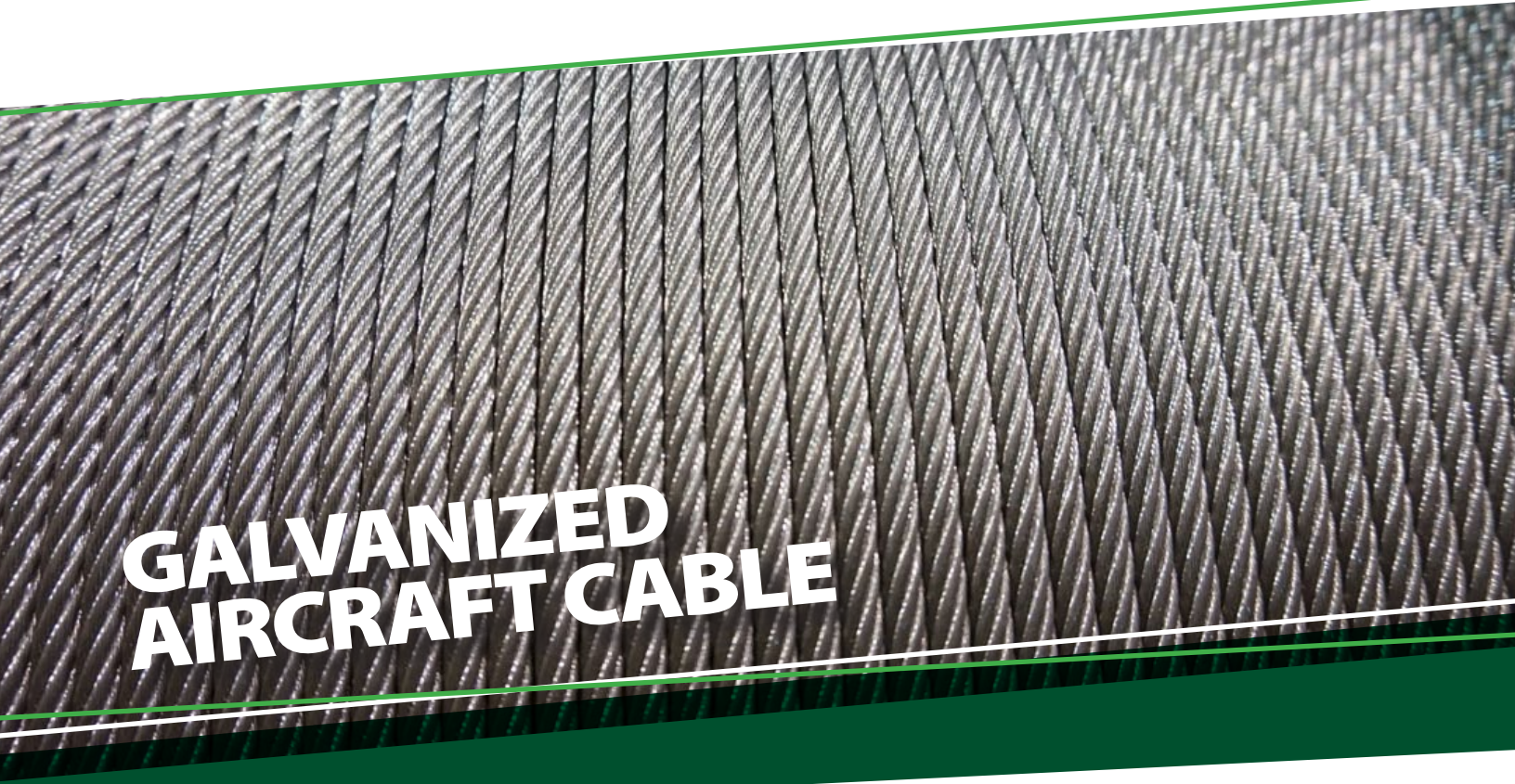

GALVANIZED AIRCRAFT CABLE

Galvanized Aircraft Cable (7x7, 7x19 IWRC RL)

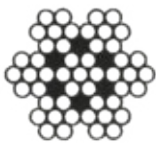

7x7



7x19

ROPE SIZE	BREAK STRENGTH (LBS.)	CONST.	LENGTH PER REEL
1/16"	480 LBS	7X7	500'
1/16"	480 LBS	7X7	1000'
1/16"	480 LBS	7X7	5000'
3/32"	920 LBS	7X7	500'
3/32"	920 LBS	7X7	1000'
3/32"	920 LBS	7X7	5000'

ROPE SIZE	BREAK STRENGTH	CONST.	LENGTH PER REEL
1/8"	2,000 LBS	7X19	1000'
1/8"	2,000 LBS	7X19	2500'
1/8"	2,000 LBS	7X19	5000'
5/32"	2,800 LBS	7X19	1000'
5/32"	2,800 LBS	7X19	2500'
5/32"	2,800 LBS	7X19	5000'
3/16"	4,200 LBS	7X19	1000'
3/16"	4,200 LBS	7X19	2500'
3/16"	4,200 LBS	7X19	5000'
1/4"	7,000 LBS	7X19	1000'
1/4"	7,000 LBS	7X19	2500'
1/4"	7,000 LBS	7X19	5000'
5/16"	9,800 LBS	7X19	500'
5/16"	9,800 LBS	7X19	1000'
5/16"	9,800 LBS	7X19	5000'
3/8"	14,000 LBS	7X19	500'
3/8"	14,000 LBS	7X19	5000'

SASKATOON

3235 Millar Avenue, Saskatoon SK S7K 5Y3 FAX: (306) 249-4374
Ph: (306) 242-7073 Toll Free: 1-800-242-7073

REGINA

125 Henderson Drive, Regina SK S4N 5W4 FAX: (306) 352-9112
Ph: (306) 352-7073 Toll Free: 1-800-242-7073

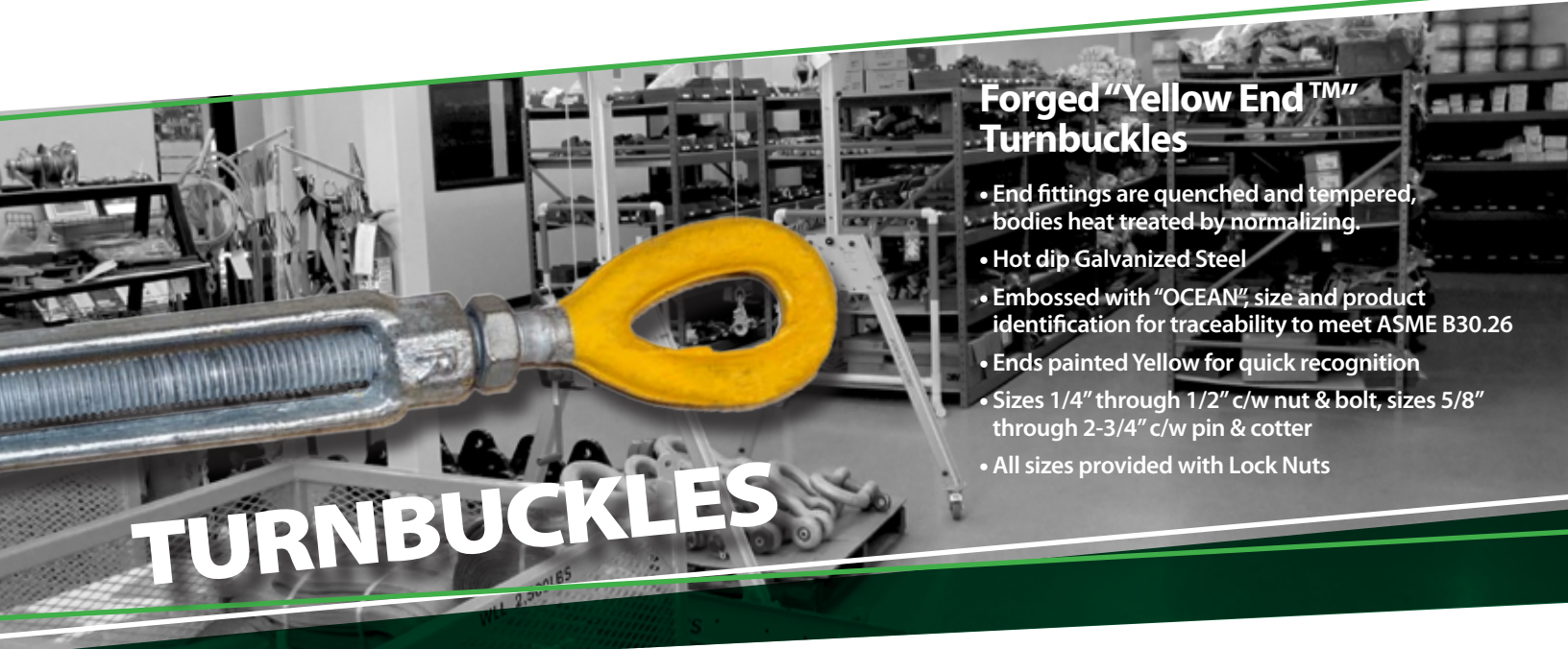

Forged "Yellow End™" Turnbuckles

- End fittings are quenched and tempered, bodies heat treated by normalizing.
- Hot dip Galvanized Steel
- Embossed with "OCEAN", size and product identification for traceability to meet ASME B30.26
- Ends painted Yellow for quick recognition
- Sizes 1/4" through 1/2" c/w nut & bolt, sizes 5/8" through 2-3/4" c/w pin & cotter
- All sizes provided with Lock Nuts

TURNBUCKLES

Turnbuckle Jaw & Jaw

- Galvanized. Conforms to Federal Specification FF-T-791B and ASTM F1145, Type 1, Form 1



SIZE	WLL (lbs.)	OPEN LENGTH	CLOSED LENGTH
1/4" X 4"	500	11.9"	7.9"
5/16" X 4 1/2"	800	13.9"	9.4"
3/8" X 6"	1,200	17.4"	11.4"
1/2" X 6"	2,200	19.0"	13.0"
1/2" X 9"	2,200	25.0"	16.0"
1/2" X 12"	2,200	31.0"	19.0"
5/8" X 6"	3,500	20.9"	14.9"
5/8" X 9"	3,500	26.9"	17.9"
5/8" X 12"	3,500	32.9"	20.9"
3/4" X 6"	5,200	22.6"	16.6"
3/4" X 9"	5,200	28.6"	19.6"
3/4" X 12"	5,200	34.6"	22.6"
3/4" X 18"	5,200	46.6"	28.6"
1" X 6"	10,000	26.1"	20.1"
1" X 12"	10,000	38.1"	26.1"
1" X 18"	10,000	50.1"	32.1"
1" X 24"	10,000	62.1"	38.1"

Turnbuckle Eye & Eye

- Galvanized. Conforms to Federal Specification FF-T-791B, Type 1, Form 1 – Class 4



SIZE	WLL (lbs.)	OPEN LENGTH	CLOSED LENGTH
5/16" X 4-1/2"	800	14.12"	9.62"
3/8" X 6"	1,200	18.16"	12.16"
1/2" X 6"	2,200	19.96"	13.96"
1/2" X 9"	2,200	25.96"	16.96"
1/2" X 12"	2,200	32.08"	19.08"
5/8" X 6"	3,500	21.68"	15.68"
5/8" X 9"	3,500	27.68"	18.68"
5/8" X 12"	3,500	34.93"	21.68"
3/4" X 9"	5,200	29.62"	20.62"
3/4" X 12"	5,200	35.62"	23.62"
7/8" X 12"	7,200	36.82"	24.82"
1" X 12"	10,000	39.97"	27.72"

Turnbuckle Stub End

- Self Colored, Conforms to Federal Specification FFT-T-791B, Type 1, Form 1 – Class 3



SIZE	WLL (lbs.)	OVERALL LENGTH
1/2" X 6"	2,200	16"
5/8" X 6"	3,500	16"
3/4" X 6"	5,200	17"
7/8" X 6"	7,200	18"
1" X 6"	10,000	19"
1-1/4" X 6"	15,200	20"
1-1/2" X 12"	21,400	26.5"

SASKATOON

3235 Millar Avenue, Saskatoon SK S7K 5Y3 FAX: (306) 249-4374
Ph: (306) 242-7073 Toll Free: 1-800-242-7073

REGINA

125 Henderson Drive, Regina SK S4N 5W4 FAX: (306) 352-9112
Ph: (306) 352-7073 Toll Free: 1-800-242-7073



STAINLESS STEEL AIRCRAFT CABLE

Stainless Steel Aircraft Cable (7x7, 7x19 IWRC RL)

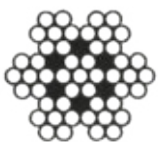

7x7



7x19

- For corrosive environments.
- Water use.
- Adverse weather.
- Any conditions where long term durability is required.

ROPE SIZE	BREAK STRENGTH (LBS.)	CONST.	LENGTH PER REEL
1/16"	480	7X7	500 FEET
3/32"	920	7X7	500 FEET
1/8"	1,700	7X19	250 FEET
5/32"	2,400	7X19	250 FEET
3/16"	3,700	7X19	300 FEET
1/4"	6,400	7X19	300 FEET
5/16"	9,000	7X19	250 FEET
3/8"	12,000	7X19	250 FEET

SASKATOON

3235 Millar Avenue, Saskatoon SK S7K 5Y3 FAX: (306) 249-4374
Ph: (306) 242-7073 Toll Free: 1-800-242-7073

REGINA

125 Henderson Drive, Regina SK S4N 5W4 FAX: (306) 352-9112
Ph: (306) 352-7073 Toll Free: 1-800-242-7073

email: sales@northernstrands.com





BRIGHT STEEL CABLE

Bright Steel (IWRC) General Purpose RRL Wire Rope



6x19

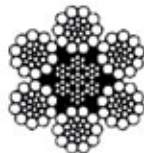

6x26



6x36

ROPE SIZE	CONST.	BREAK STRENGTH (LBS.)	LENGTH PER REEL
3/8"	6X19/6X26	15,100	5000'
7/16"	6X19/6X26	20,400	5000'
1/2"	6X19/6X26	26,600	5000'
9/16"	6X19/6X26	33,600	5000'
5/8"	6X19/6X26	41,200	5000'
3/4"	6X19/6X26	58,800	2500'
7/8"	6X19/6X26	79,600	2500'
1"	6X19/6X26	103,400	2000'
1-1/8"	6X19/6X26	130,000	2000'

ROPE SIZE	CONST.	BREAK STRENGTH (LBS.)	LENGTH PER REEL
3/8"	6X36	15,100	5000'
7/16"	6X36	20,400	5000'
1/2"	6X36	26,600	5000'
9/16"	6X36	33,600	5000'
5/8"	6X36	41,200	5000'
3/4"	6X36	58,800	2500'
7/8"	6X36	79,600	2500'
1"	6X36	103,400	2000'
1-1/8"	6X36	130,000	2000'
1-1/4"	6X36	159,800	1500'

SASKATOON

3235 Millar Avenue, Saskatoon SK S7K 5Y3 FAX: (306) 249-4374
Ph: (306) 242-7073 Toll Free: 1-800-242-7073

REGINA

125 Henderson Drive, Regina SK S4N 5W4 FAX: (306) 352-9112
Ph: (306) 352-7073 Toll Free: 1-800-242-7073